

# **MEDICAL DEVICE GUIDANCE DOCUMENT**

## **GUIDANCE ON THE PRODUCT GROUPING**



<b>Contents</b>	<b>Page</b>
Preface .....	iii
Introduction .....	iv
1 Purpose .....	1
2 Scope.....	1
3 Term and definitions.....	1
4 General Principles of Grouping.....	3
5 Categories.....	5
5.1 Single .....	5
5.2 System .....	5
5.3 Family.....	7
5.4 Set.....	10
5.5 IVD Test Kit .....	11
5.6 IVD Cluster .....	12
ANNEX 1: Decision Flowchart for Grouping of Products as a System.....	14
ANNEX 2: Decision Flowchart for Grouping of Medical Devices as a Family .....	15
ANNEX 3: Permissible Variants in a Family .....	16
ANNEX 4: Special Grouping Rule for Class A Reusable .....	18
ANNEX 5: Decision Flowchart for Grouping of Products as a IVD Test Kit .....	20
ANNEX 6: List of IVD Cluster Categories .....	21
ANNEX 7: Decision Flowchart for Grouping of Products as An IVD Cluster .....	30
Figure 1: Example of referencing the headquarters as the manufacturer for the purpose of grouping .....	4
Figure 2: Example on Grouping of Systems as a Family .....	9
Figure 3 Example of an IVD CLUSTER .....	13

## **Preface**

This Guidance Document was prepared by the Medical Device Authority (MDA) to help the industry and healthcare professionals in their quest to comply with the Medical Device Act (Act 737) and the regulations under it.

This Guidance Document shall be read in conjunction with the current laws and regulations used in Malaysia, which include but not limited to the following-

- a) Medical Device Act 2012 (Act 737); and
- b) Medical Device Regulations 2012.

In this Guidance Document, the following verbal forms are used:

- “shall” indicates a requirement;
- “should” indicates a recommendation;
- “may” indicates a permission; and
- “can” indicates a possibility or a capability.

Irrespective of the requirements of this Guidance Document, MDA has the right to request for information or material, or define conditions not specifically described in this document that is deemed necessary for the purpose of regulatory control.

MDA has put much effort to ensure the accuracy and completeness of this guidance document. In the event of any contradiction between the contents of this document and any written law, the latter should take precedence.

MDA reserves the right to amend any part of the guidance document from time to time.

## **CONTACT INFORMATION**

For further information, please contact:

### **MEDICAL DEVICE AUTHORITY**

Ministry of Health Malaysia  
Level 6, Prima 9, Prima Avenue II,  
Block 3547, Persiaran APEC,  
63000 Cyberjaya, Selangor,  
MALAYSIA  
Fax: (03) 8230 0200  
Email: [mdb@mdb.gov.my](mailto:mdb@mdb.gov.my)  
Website: <http://www.mdb.gov.my>

## **Introduction**

Under the Medical Device Act 2012, the manufacturer or the Local Authorized Representative of the foreign manufacturer is required to register a medical device before importing, exporting or placing it in the Malaysia market.

There is a wide range of medical devices from a simple medical device to a highly complex and sophisticated medical device. The various components can be sold as a separate component, individual customized pack or group and can be categorized as SINGLE, FAMILY, SYSTEM, SET, IVD TEST KIT, and IVD CLUSTER. Each of the categories mentioned can be submitted in the medical device registration application.

# GUIDANCE ON THE PRODUCT GROUPING

## 1 Purpose

The purpose of this document is to provide guidance to determine the appropriate grouping for medical devices in the medical device registration application.

## 2 Scope

This document applies to all products that fall within the definition of medical device that has been specified in the Guidance Document: *Definition of Medical Device* (MDA/GD/0006).

## 3 Terms and definitions

For the purposes of this document, the following terms and definitions apply.

### 3.1 Accessory

For the purposes of this guidance document, an accessory is an article that is intended specifically by its manufacturer to:

- (a) be used together with a medical device to enable that device to be used in accordance with its intended purpose as a medical device; or
- (b) augment or extend the capabilities of that device in fulfillment of its intended purpose as a medical device;

and therefore should be considered as a medical device.

### 3.2 Component

One of several possibly unequal subdivisions which together constitute the whole medical device to achieve the latter's intended purpose. A component may be known as a part but not a medical device in its own right.

### 3.3 Generic Proprietary Name

A unique name given by the manufacturer to identify a medical device as a whole product, also known as the trade name or brand name.

### **3.4 Intended Purpose**

The use for which the medical device is intended according to the specifications of its manufacturer as stated on any or all of the following:

- (a) the label of the medical device;
- (b) the instructions for use of the medical device;
- (c) the promotional materials in relation to the medical device.

### **3.5 Authorised Representative (AR)**

- (a) a person domiciled or resident in Malaysia; or
- (b) a firm or company constituted under the laws of Malaysia, and carrying on business or practice principally in Malaysia.

### **3.6 Manufacturer**

Means —

- (a) a person who is responsible for
  - (i) the design, production, fabrication, assembly, processing, packaging and labelling of a medical device whether or not it is the person, or a subcontractor acting on the person's behalf, who carries out these operations; and
  - (ii) assigning to the finished medical device under his own name, its intended purpose and ensuring the finished product meets the regulatory requirement;

Or

- (b) any other person who-
  - (i) assembles, packages, processes, fully refurbishes, reprocesses or labels one or more ready- made medical devices; and
  - (ii) assigning to the ready- made medical device under his own name, its intended purpose and ensuring the finished product meets the regulatory requirement,

but shall not include the following persons:

- (A) Any person who assembles or adapts medical devices in the market that are intended for individual patients; and

- (B) Any person who assembles, packages, or adapts medical devices in relation to which the assembling, packaging or adaptation does not change the purpose intended for the medical device.

### **3.7 Medical Device**

Refer to MDA/GD/0006: Definition of Medical Device.

### **3.8 Reusable Surgical Instrument**

Instrument intended for surgical use by cutting, drilling, sawing, scratching, scraping, clamping, retracting, clipping or other surgical procedures, without connection to any active medical device and which are intended by the manufacturer to be reused after appropriate procedures for cleaning, disinfection and/or sterilisation have been carried out.

## **4 General Principles of Grouping**

**4.1** Medical devices that can be grouped into one of the following five categories can be submitted in one application for product registration and listing in the Malaysia Medical Device Register (MMDR):

- a) SINGLE;
- b) FAMILY;
- c) SYSTEM;
- d) SET;
- e) IVD TEST KIT;
- f) IVD CLUSTER.

**4.2** The Three basic rules must all be fulfilled for the grouping to apply. These are:

- a) one generic proprietary name;
- b) one manufacturer; and
- c) one common intended purpose.

**4.3** For the purpose of grouping, the corporate headquarters may be regarded as the manufacturer for its subsidiaries and regional manufacturing sites.

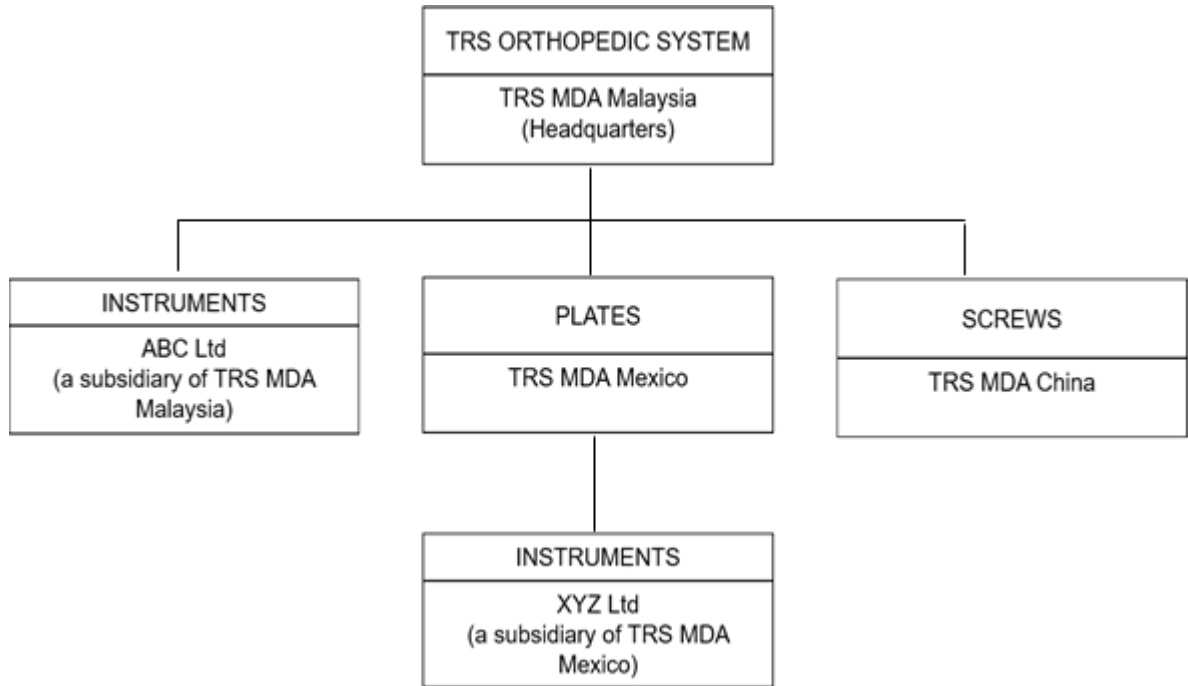

**Figure 1: Example of referencing the headquarters as the manufacturer for the purpose of grouping**

**4.4** For example, TRS MDA ORTHOPAEDIC SYSTEM consists of the following constituent-components (refer to Figure 1):

- a) Instruments from ABC Bhd (a subsidiary of TRS MDA Malaysia),
- b) Instruments from XYZ Bhd (a subsidiary of TRS MDA Mexico),
- c) Plates from TRS MDA Mexico; and
- d) Screws from TRS MDA China

For the purpose of grouping, the manufacturer of TRS ORTHOPAEDIC SYSTEM will be TRS MDA Malaysia (Headquarters).



## 5 Categories

### 5.1 *Single*

A SINGLE medical device is a medical device from a manufacturer identified by a medical device proprietary name with a specific intended purpose. It is sold as a distinct packaged entity. It may be offered in a range of package sizes.

The Examples:

- a) Condoms that are sold in packages of 3, 12 and 144 can be registered as a SINGLE medical device.
- b) A company manufactures a software program that can be used with a number of CT scanners produced by other manufacturers. Although the software cannot function on its own, it can be used on different scanners. The software can be registered as a SINGLE medical device.
- c) A company that assembles and registers a first aid kit has now decided to also supply each of the medical devices in the first aid kit individually. Each medical device supplied individually as a medical device must be registered separately as a SINGLE medical device.

### 5.2 *System*

**5.2.1** A medical device SYSTEM comprises of a number of constituent-components that are:

- a) from the same manufacturer;
- b) intended to be used in combination to complete a common intended purpose;
- c) compatible when used as a SYSTEM; and
- d) sold under a SYSTEM name or the labelling, instruction for use (IFU), brochures or catalogues for each constituent component states that the constituent component is intended for use with the SYSTEM.

*NOTE Constituent-components registered as part of a system shall only be supplied specifically for use with that SYSTEM. Any constituent-component that is meant for supply for use with multiple SYSTEMs should be registered together with each of these other SYSTEMs. Alternatively, these constituent-component(s) that are compatible for use with multiple SYSTEMs must be registered separately.*

**5.2.2 The decision flowchart for grouping of products as an SYSTEM can be found in Annex 1.**

In addition, if several SYSTEMs fulfil the following conditions to be grouped as a FAMILY, they may be registered as a FAMILY:

- a) the SYSTEMs are from the same manufacturer;
- b) the SYSTEMs are of the same risk classification class;
- c) the SYSTEMs have a common intended purpose;
- d) the SYSTEMs have the similar design and manufacturing process; and
- e) key constituent-components of the SYSTEMs have variations that are within the scope of the permissible variants.
- f) has the same generic proprietary name.

**5.2.3** Individual SYSTEM names may contain additional descriptive phrases.

The Registrant has to undertake the following post-market duties and obligations for all the constituent-components in the registered SYSTEM, regardless of whether the constituent-components are from the same manufacturer of the SYSTEM:

- a) comply with the conditions applicable to the registered medical device and conditions imposed on the Registrant;
- b) submit applications to the Authority for changes made to the registered medical device;
- c) maintain records of supply;
- d) maintain records of complaints;
- e) report defects and adverse effects to the Authority, and
- f) notify the Authority concerning field safety corrective action (FSCA), including recall.

**5.2.4** An In Vitro Diagnostic (IVD) Medical Device SYSTEM may typically consist of TEST KITS and instruments (e.g. an analyser designed to be used with that TEST KIT).

Examples:

- a) A hip replacement SYSTEM comprising of femoral and acetabular components can be registered as a SYSTEM. The components must be used in combination to achieve a common intended purpose of total hip replacement. The size of the components may vary.
- b) An electrosurgical unit and its accessories that consist of forceps, electrodes, electrode holders, leads, plug adaptor, when used together for a common intended purpose, can be registered as a SYSTEM.

- c) Optional accessory such as wireless controller is part of In-the-ear hearing aid can be registered as a SYSTEM.
- d) A glucose monitoring SYSTEM comprising of a glucose meter, test strips, control solutions and linearity solutions can be registered as a SYSTEM.

### **5.3 Family**

**5.3.1** A medical device FAMILY is a collection of medical devices and each medical device FAMILY member:

- a) is from the same manufacturer;
- b) is of the same risk classification;
- c) has the same medical device proprietary name;
- d) has a common intended purpose;
- e) has the same design and manufacturing process; and
- f) has variations that are within the scope of the permissible variants.

The decision flowchart for grouping of products as an FAMILY can be found in **Annex 2**.

**5.3.2** A characteristic of a medical device may be considered a permissible variant if:

- a) the physical design and construction of the medical devices are the same, or very similar;
- b) the manufacturing processes for the medical devices are the same, or very similar;
- c) the intended purpose of the medical devices is the same; and
- d) the risk profile of the medical devices, taking into account the above factors, is the same.

See **Annex 3** for a list of permissible variants in a FAMILY.

**5.3.3** If medical devices satisfy the above conditions to be grouped as a FAMILY, but have different device proprietary names, the products will be listed separately on the Malaysia Medical Device Register (MMDR) based on their proprietary name.

**5.3.4** Information on all medical devices within a FAMILY must be submitted as part of one product registration application. Only members of a FAMILY that are eventually listed on the register shall be supplied on the market. Those that are not listed shall not be supplied on the market.

**5.3.5** The medical device proprietary name must appear on the label of each of the member medical devices. Individual medical device names may contain additional descriptive phrase.

**5.3.6** A special grouping rule is applicable for Class A reusable surgical instruments. See **Annex 4** for this grouping rule.

Examples:

- a) Condoms that differ in colour, size and texture but are manufactured from the same material and manufacturing process and share a common intended purpose can be registered as a FAMILY.
- b) IV administrative sets that differ in features such as safety features and length of tubing, but are manufactured from the same material and manufacturing process and share a common intended purpose can be registered as a FAMILY.
- c) Steerable guidewires that are available in various lengths and possess various tip shapes and tip flexibilities can be registered as a FAMILY if their variations fall within the scope of permissible variants.
- d) Spherical contact lens with additional features of UV protection, can be registered as part of a FAMILY, as this feature does not affect the basic design and manufacturing of the lens.
- e) In-the-ear hearing aids which are designed in different sizes to be fitted in the ear (i.e. outer ear, middle ear, and inner ear canal), and have been designed using the same main components including the signal processor and compression circuit, microphone, amplifiers, and receiver, can be registered as a FAMILY.
- f) Automated blood pressure monitors with optional features such as memory storage and print capability can be considered as part of a FAMILY.
- g) Cardiac catheters that are available in a different number of lumens, lengths and diameters can be registered as a FAMILY.
- h) Contact lenses are available as toric lens and spherical lens. These products have different intended purposes and performances. They are designed and manufactured differently. Due to these differences, they shall not be considered as members of a FAMILY.

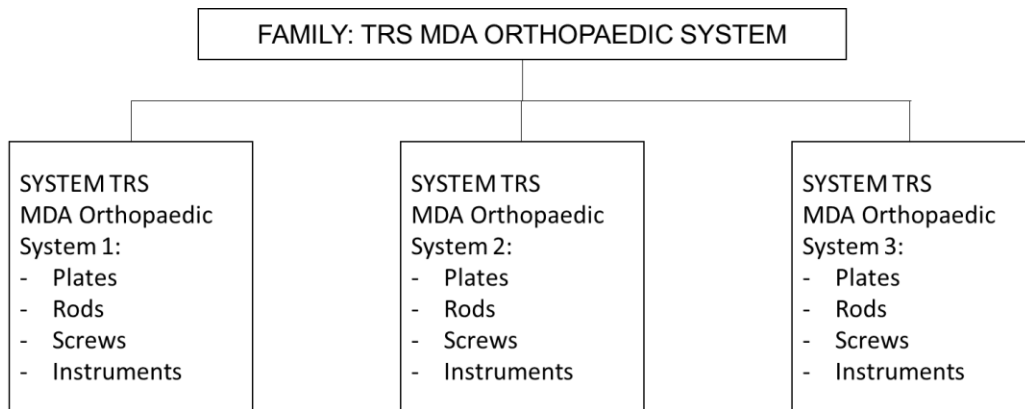

*Note: The key constituent-components, i.e. implantable rods, plates and screws, across the Systems are within permissible variants. For example, differences in lengths of the implantable screws are deemed permissible variants.*

**Figure 2: Example on Grouping of Systems as a Family**

*Information on all the constituent-components within a System must be submitted as part of one product registration application. Only constituent-components within a SYSTEM that are eventually on the register shall be supplied on the market. Those that are not listed shall not be supplied on the market*

*If the constituent-component in a SYSTEM is supplied for use in more than one SYSTEM, such as constituent-components shall be included in the registration application for each of the other SYSTEMs.*

## **5.4 SET**

**5.4.1** A medical device SET is a collection of two or more medical devices, assembled together as one package by a manufacturer. The medical device SET has the following:

- a) a single proprietary SET name;
- b) a common intended use;
- c) classification allocated to the set is at the level of the highest classified device within the set.

**5.4.2** Each medical device in the SET may have different medical device proprietary names and intended purposes, may be designed and manufactured by different manufacturers.

**5.4.3** When the SET is registered, the manufacturer is able to customize the set for particular hospitals or physicians, while maintaining the same SET name and intended purpose. When the SET is registered, all other combinations in that SET can be supplied on the market.

**5.4.4** The collection of medical devices in a SET may differ in number and combination of products that comprise each SET while maintaining the same proprietary SET name and SET's intended use.

**5.4.5** Information on all medical devices within a SET must be submitted as part of one product registration application. Only medical devices within a SET that are eventually listed on the register shall be supplied on the market. Those that are not listed shall not be supplied on the market. Medical devices that are registered as part of a SET must have a SINGLE medical device registration before they are sold separately as individual medical devices.

**5.4.6** If a medical device in a SET is supplied for use in another SET, such a medical device shall be included in the registration application of that other SET.

**5.4.7** The SET name indicated for the medical device must appear in the product label affixed on the external package of the SET. Individual medical devices in the SET do not require to be labelled with that SET name. Individual medical devices in the SET may contain additional descriptive phrases.

**5.4.8** The Registrant has to undertake the following post-market duties and obligations for all the constituent-components in the registered SET, regardless of whether the constituent-components are from the same manufacturer of the SET:

- a) comply with the conditions applicable to the registered medical device and conditions imposed on the Registrant;

- b) submit applications to the Authority for changes made to the registered medical device;
- c) maintain records of supply;
- d) maintain records of complaints;
- e) report defects and adverse effects to the Authority and
- f) notify the Authority concerning field safety corrective action (FSCA), including recall.

#### **5.4.9 Examples:**

- a) A first aid kit consisting of medical devices such as bandages, gauzes, drapes and thermometers, when assembled together as one package by a manufacturer, can be registered as a SET.
- b) A dressing tray consisting of a number of medical devices when packaged together for convenience to meet a specific purpose by a manufacturer can be registered as a SET.
- c) A manufacturer supplies dressing trays customised with different quantity and type of gauze and sutures to different hospitals while maintaining the same SET name and intended purpose.
- d) A promotional pack consisting of different number of medical devices, for example multi-purpose solution, saline solution, and contact lens case, will not require a SET registration. Individual medical devices shall require registration as SINGLE medical devices.

### **5.5 IVD Test Kit**

**5.5.1** An IVD TEST KIT is an in vitro diagnostic (IVD) device that consists of reagents or articles that are:

- a) from the same manufacturer;
- b) intended to be used in combination to complete a specific intended purpose;
- c) sold under a single TEST KIT name or the labelling, instructions for use (IFU), brochures or catalogues for each reagents or article states that the component is intended for use with the IVD TEST KIT; and
- d) compatible when used as a TEST KIT.

**5.5.2** An IVD TEST KIT does not include the instruments, such as analysers, needed to perform the test.

**5.5.3** The decision flowchart for grouping of products as an IVD TEST KIT can be found in **Annex 5**.

**5.5.4** Information on all reagents or articles within an IVD TEST KIT must be submitted as part of one product registration application. Only those reagents or articles within an IVD TEST KIT that are eventually listed on the register shall be supplied on the market. Those that are not listed shall not be supplied on the market.

**5.5.5** Individual reagents or articles can be supplied separately as replacement items for the kit. If the reagents or articles in a TEST KIT are supplied for use in more than one TEST KIT, such reagents or articles shall be included in the product registration application of each of the other TEST KITS.

**5.5.6** Reagents or articles from another manufacturer may be registered with the IVD TEST KIT. The Registrant has to undertake the following post-market duties and obligations for all the reagents and articles in the registered IVD TEST KIT, regardless of whether the reagents or articles are from the same manufacturer of the IVD TEST KIT:

- a) comply with the conditions applicable to the registered medical device and conditions imposed on the Registrant;
- b) submit applications to the Authority for changes made to the registered medical device;
- c) maintain records of supply;
- d) maintain records of complaints;
- e) report defects and adverse effects to the Authority and
- f) notify the Authority concerning field safety corrective action (FSCA), including recall.

**5.5.7** Examples:

A Human Immunodeficiency Virus (HIV) Enzyme Linked ImmunoSorbent Assay (ELISA) TEST KIT may contain controls, calibrators and washing buffers. All the reagents and articles are used together to detect HIV and therefore can be registered as a TEST KIT. These reagents and articles can be supplied separately as replacement items for that particular TEST KIT.

## **5.6 IVD CLUSTER**

**5.6.1** An IVD CLUSTER comprises of a number of in vitro diagnostic reagents or articles that are:

- a) from the same manufacturer;



- b) within risk classification A or B;
- c) of a common test methodology as listed in **Annex 6**; and
- d) of the same IVD CLUSTER category as listed in **Annex 6**.

**5.6.2** The IVD CLUSTER may include analysers that are designed for use with the reagents in the IVD CLUSTER.

**5.6.3** A closed list of common test methodologies and IVD CLUSTER categories is provided in **Annex 6**.

**5.6.4** The decision flowchart for grouping of products as an IVD CLUSTER can be found in **Annex 7**.

**5.6.5** Information on all reagents or articles within an IVD CLUSTER must be submitted as part of one product registration application. Only those reagents or articles within an IVD CLUSTER that are eventually listed on the register shall be supplied on the market. Individual reagents or articles that are listed as part of a CLUSTER can be supplied separately.

**5.6.6** If a reagent or article is intended for multiple usage categories such that it can be grouped in more than one IVD CLUSTER, the Registrant can choose to group the reagent or article as part of any one of the IVD CLUSTERS it qualifies. Information to support all the intended purposes of the reagent or article must be submitted as part of the product registration application.

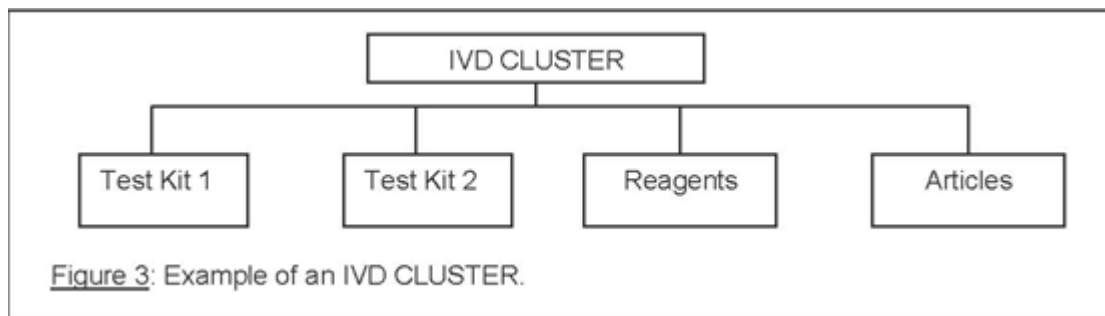

**Figure 3 Example of an IVD CLUSTER**

*Individual (single) reagents or articles, test kits or families of reagents or articles within an IVD CLUSTER (Figure 3), shall be listed separately on the Medical Device Register.*

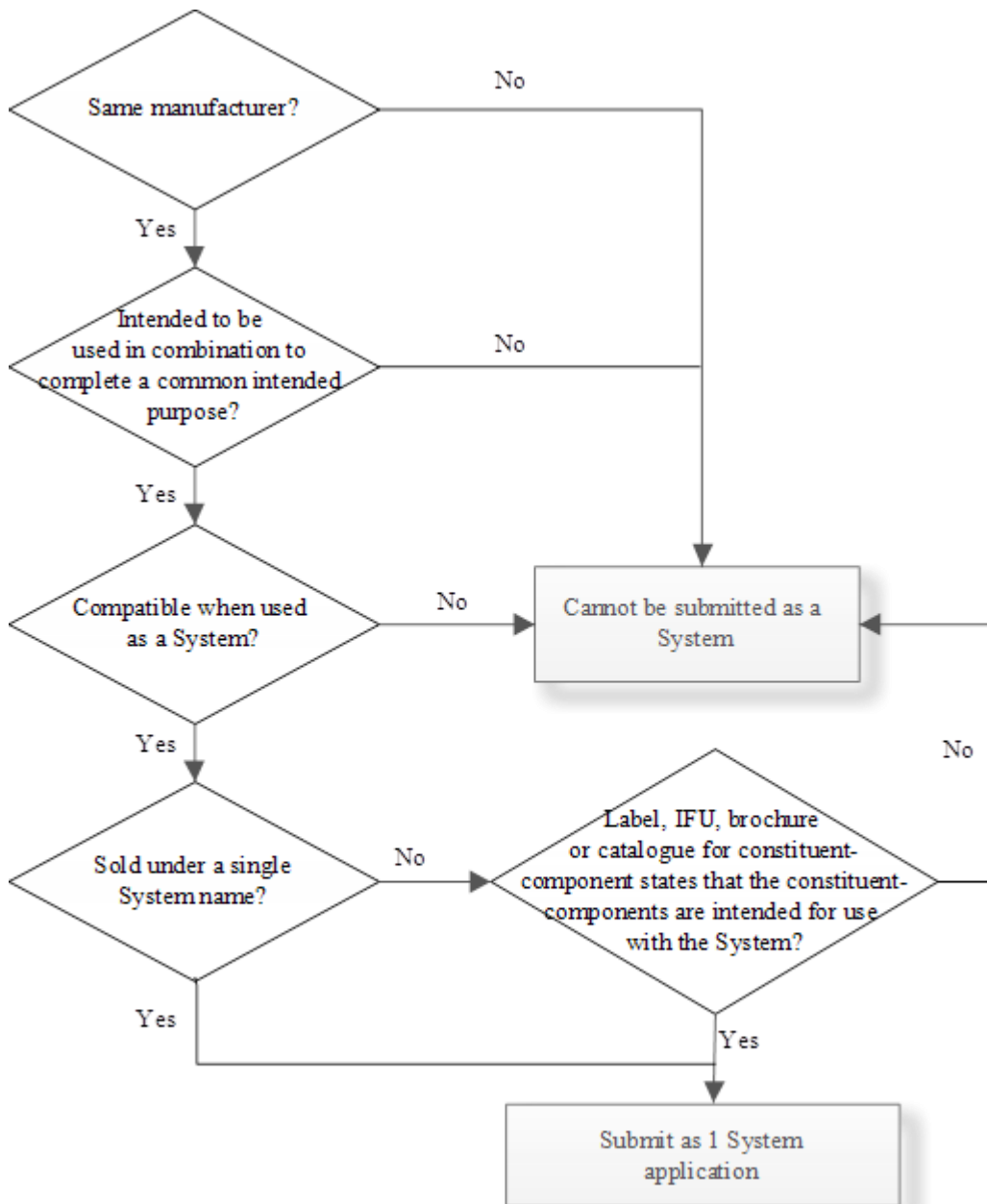
**ANNEX 1: Decision Flowchart for Grouping of Products as a System**

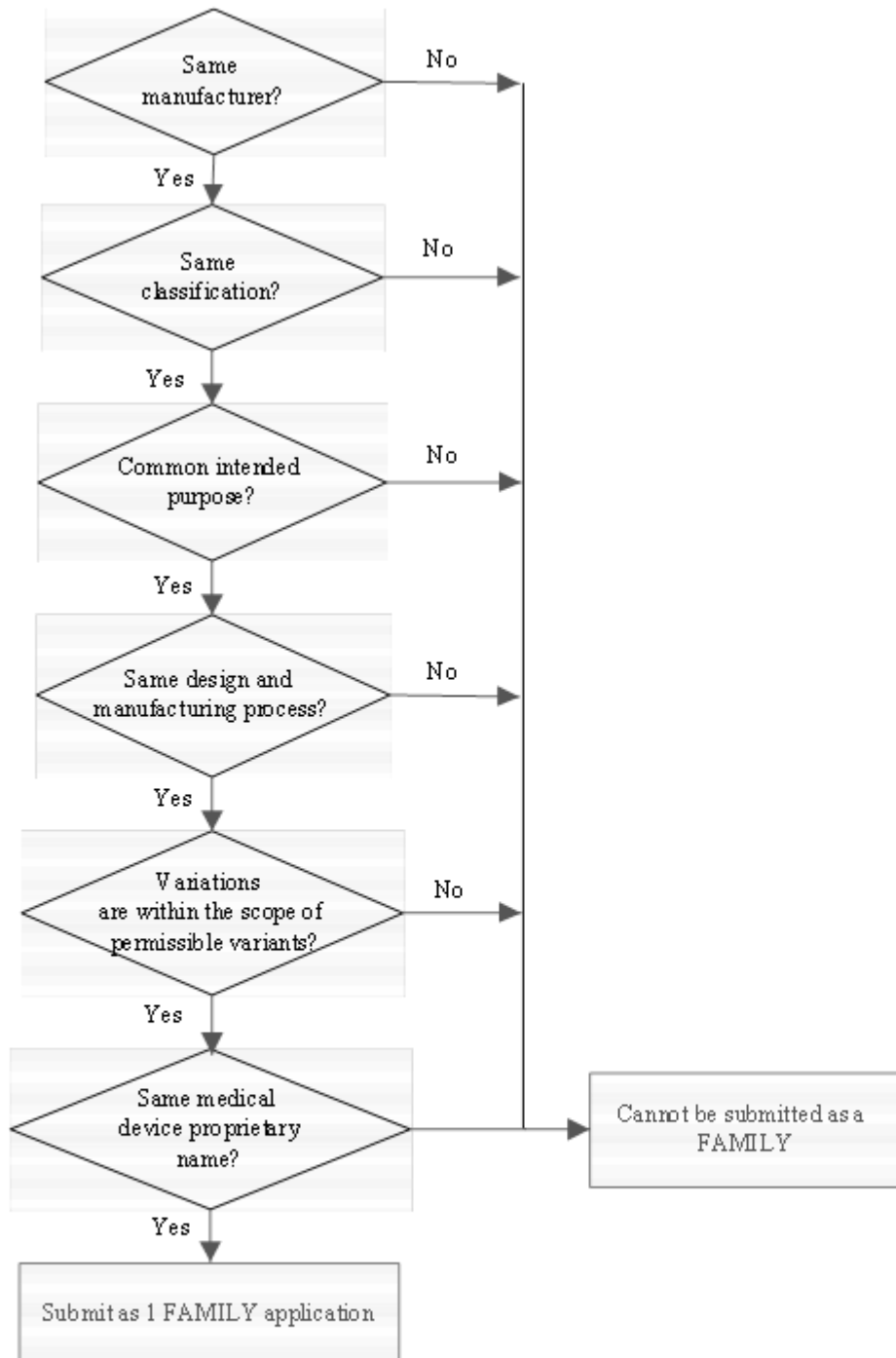
**ANNEX 2: Decision Flowchart for Grouping of Medical Devices as a Family**

**ANNEX 3: Permissible Variants in a Family**

The list of permissible variants is a closed and positive list.

<b>Specific products</b>	<b>Permissible variants</b>
Antibiotic test	(i) Concentrations
Catheter	(i) Number of lumens in catheter (ii) Material of catheter: PVC (polyvinylchloride), PU (polyurethane), nylon and silicone (iii) Curvature (straight or pigtail) Polymer products-with or without DEHP Stent- delivery system, that is over-the –wire or through the scope
IV Cannula	(i) Presence of injection port (ii) Presence of safety features
Condoms	(i) Texture (ii) Flavour
Contact lens	(i) Diopter, (ii) UV protection (iii) Tinting
Electrophysiological Catheter	(i) Electrode spacing (ii) (ii) Number of electrodes
Suture	(i) Number of strands (ii) Pledgets
Suture passer	(i) Design of jaw, handle or needle
Dental handpieces	(i) Rotational speed (ii) Material of handpiece
Dental brackets	(i) Material of bracket
IVD rapid tests	(i) Different assembly format: cassette, midstream, strip
IVD urinalysis strips	(i) Different combination of testing configurations
Polymer Products	(i) With or Without DEHP
Stent	1)Delivery system, that is over –the-wire or through the scope

<b>Other permissible variants in general</b>
Colour
Diameter
Flexibility
Gauge
Holding force
Isotope activity level
Length
Memory storage
Print capability
Radiopacity
Shape
Size
Volume
Width
Viscosity (The change in viscosity is solely due to changes in the concentration of constituent material)
Type of monitoring (e.g. ceiling mount, wall mount or standing) Dimensional design differences due to pediatric versus adult use (the differences due to the different patient population are permissible, e.g. volume and length)

## ANNEX 4: Special Grouping Rule for Class A Reusable

### Surgical Instruments

A special grouping rule is applicable to Class A reusable surgical instruments.

The special grouping rule states that reusable surgical instruments can be grouped together as 1 FAMILY if they satisfy the following conditions:

- are from the same manufacturer
- same overall intended purpose (This refers to the overall intended purpose of the instrument, regardless of location of the body they are used on).

For example, Class A lung retractor and Class A kidney retractor have the same overall intended purpose as they are both retractors. However, lung forceps and lung retractors do not have the same overall intended purpose and therefore cannot be grouped together as a FAMILY.

This special grouping rule is only applicable to Class A reusable surgical instruments. It is not applicable to Class B, C and D reusable surgical instruments.

Example:

Instrument name	Description	Intended purpose
ABC Dressing Forceps	Delicate, Serrated Tips, Straight, 4¾"	To pick up or grasp tissue or items in the surgical wound
DEF Kidney Forceps	Half curved, 222 mm length	To grasp renal polyps
HIJ Lung Forceps	Triangular jaws, jaw width 11", length 8"	To grasp lung tissue
XYZ Uterine Biopsy Forceps	Oblong basket jaw, jaw size 3x10mm, shaft length 10"	To grasp tissue during transvaginal or transrectal tissue biopsy

In the example above, the forceps have the same manufacturer, but have different proprietary names (ABC, DEF, HIJ and XYZ) and different intended purposes. These forceps are Class A medical devices.

These forceps can be grouped as a FAMILY and registered as part of one application on the basis of the special grouping rule for Class A reusable surgical instrument because:

- they are Class A reusable surgical instruments,
- the manufacturer is the same for all instruments, and
- they have the same overall intended purpose (i.e. to grasp).

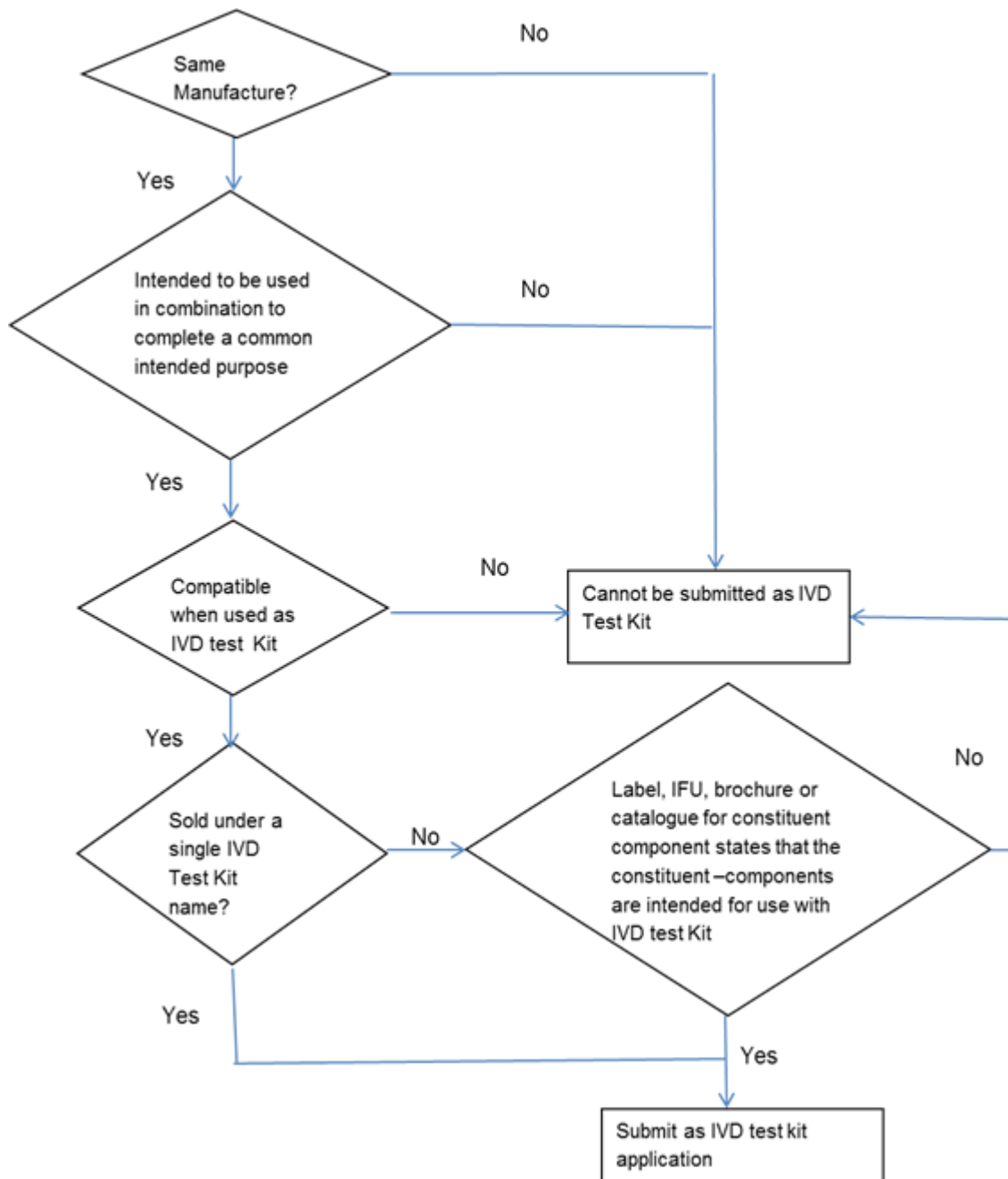
**ANNEX 5: Decision Flowchart for Grouping of Products as a IVD Test Kit**



**ANNEX 6: List of IVD Cluster Categories**

This list of IVD CLUSTER categories is only applicable to **Class A and Class B IVD**. It should be clearly stated in the label or IFU of each reagent or article that it is intended for use, whether alone or in combination, for the same category:

	Methodology	CLUSTER Category (closed list)	Examples of Analytes (non-exhaustive list)
1	Clinical Chemistry	Enzymes	(i) Acid Phosphatase (ii) Alpha-Amylase (iii) Creatine Kinase (iv) Gamma-GlutamylTransferase (v) Lactate Dehydrogenase (vi) Lipase
2		Substrates	(i) Albumin (ii) Bilirubin (iii) Urea/Blood Urea Nitrogen (iv) Cholesterol (v) Creatinine (vi) Glucose
3		Electrolytes Reagents	(i) Ammonia (ii) Bicarbonate (iii) Calcium (iv) Chloride (v) Magnesium (vi) Phosphate Inorganic/Phosphorus
4		Electrolyte Electrodes	(i) Ammonia Electrodes (ii) Carbon Dioxide (Bicarbonate) Electrodes (iii) Calcium Electrodes (iv) Chloride Electrodes

			(v) Magnesium Electrodes (vi) Potassium Electrodes
5		Substrate Electrodes/Biosensors	(i) Creatinine Electrodes (ii) Glucose Electrodes (iii) Glycated Hemoglobin Electrodes (iv) Lactate Electrodes (v) Urea Electrodes (vi) Bilirubin Electrodes
6	Immunochemistry	Immunoglobulins (without IgE).	(i) Immunoglobulin A (ii) Immunoglobulin D (iii) Immunoglobulin G (iv) Immunoglobulin M (v) Kappa and Lambda chain (vi) Immunofixation kits
7		Complement Components	(i) Complement Component C1q (ii) Complement Component C1 inactivator (iii) Complement Component C3/C3c (iv) Complement Component for Bb (v) Complement Component C4 (vi) Complement Component C5a
8		Transport Proteins	(i) Albumin (ii) Ceruloplasmin (iii) Haptoglobin (iv) Hemopixin (v) Lactoferrin (vi) Pre-albumin/Transthyretin
9		Lipoproteins	(i) Apolipoprotein A I (ii) Apolipoprotein A II

			(iii) Apolipoprotein B (iv) Apolipoprotein E Sub-typing (v) Lipoprotein (a)
10		Other Specific Proteins	(i) a1-Acid Glycoprotein (ii) a1-Antitrypsin (iii) a2-Macroglobulin (iv) a1-Microglobulin (v) Fibronectin (vi) Immuno Reactive Trypsin
11		Allergy	(i) Immunoglobulin E – Total (ii) Immunoglobulin E – Screen (iii) Immunoglobulin E – Specific, monotest/monoresult (iv) Allergene specific IgA (v) Allergene specific IgG
12		Cancer markers	(i) BR-marker CA15-3 (ii) GI-marker CA19-9, CA242 (iii) Carcinoembryonic Antigen (iv) Total Prostatic Specific Antigen (v) Alphafetoprotein (AFP) (vi) p53
13		Thyroid Function Markers	(i) Free Triiodothyronine (ii) Free Thyroxine (iii) Thyroid Stimulating Hormone (iv) T – Uptake (v) Thyroglobulin (vi) Neonatal Thyroxine
14		Fertility/Pregnancy Hormones/ Proteins	(i) Androstenedione (ii) Estradiol

			<ul style="list-style-type: none"> <li>(iii) Prolactin</li> <li>(iv) Human Chorionic Gonadotropin Total</li> <li>(v) Human Placental Lactogen</li> <li>(vi) Estriol</li> </ul>
15		Diabetes Assays (Hormones)	<ul style="list-style-type: none"> <li>(i) C-Peptide</li> <li>(ii) Glucagon</li> <li>(iii) Insulin</li> <li>(iv) Glycosylated / Glycated Haemoglobin</li> <li>(v) Islet Cell Ab</li> <li>(vi) Proinsulin</li> </ul>
16		Renal Metabolism Assays	<ul style="list-style-type: none"> <li>(i) Aldosterone</li> <li>(ii) Angiotensin I / II</li> <li>(iii) Angiotensin Converting Enzyme</li> <li>(iv) Cortisol</li> <li>(v) Renine</li> </ul>
17		Bone and Mineral Metabolism Assays	<ul style="list-style-type: none"> <li>(i) Bone Alkaline Phosphatase</li> <li>(ii) Calcitonin</li> <li>(iii) Cross-linked C-Telopeptides</li> <li>(iv) Cross-linked N-Telopeptides</li> <li>(v) Cyclic Adenosin Monophosphate</li> <li>(vi) Hydroxyproline</li> </ul>
18		Endocrine Hormones and Peptides	<ul style="list-style-type: none"> <li>(i) Adrenocorticotrophic Hormone</li> <li>(ii) Human Growth Hormone</li> <li>(iii) Insulin-like Growth Factor I</li> <li>(iv) Insulin-like Growth Factor Binding Protein 1</li> <li>(v) Vasointestinal Peptide</li> <li>(vi) Vasopressin</li> </ul>

19		Neuroendocrine Function Assays	(i) Bombesin (ii) 17-Hydroxy-Ketosterone (iii) $\beta$ -Endorphin (iv) Neurotensin (v) Somatostatin (vi) Substance P
20		Other Individual and Specified Hormones	(i) Gastrin (ii)Gonadotropin-Releasing Hormone (iii) Melatonin (iv) Pepsinogen (v) Adrenalin (vi) Dopamine
21		Anaemia	(i) Erythropoietin (ii) Ferritin (iii) Folate (iv) Iron (v) Iron Binding Capacity (vi) Soluble Transferrin Receptor
22		Vitamins	(i) Vitamin B1 (ii) Vitamin B2 (iii) Vitamin B6 (iv) Vitamin B12 (v) Vitamin D (Cholecalciferol) (vi)Intrinsic Factor (Blocking Antibody)
23		Non-Immuno Suppressive Therapeutic Monitoring Drug	(i) Phenobarbitol (ii) Digitoxin (iii) Gentamicin (iv) Valproic Acid (v) Caffeine

			(vi) Theophylline (vii) Methotrexate
24		Immunosuppressive Therapeutic Drug Monitoring	(i) Cyclosporine (ii) Tacrolimus (iii) Rapamycin (Sirolimus) (iv) Mycophenolate
25		Toxicology	(i) Amphetamines (ii) Cocaine (iii) Barbiturates (iv) Morphines (v) Phencyclidine (vi) Acetaminophen (vii) Catecholamines (viii) Ethanol (ix) Salicylate
26		Auto-immune Diseases	(i) Anti-nuclear antibodies (ANAs) (ii) Anti-topoisomerase (iii) Organ-specific autoantibodies (iv) Circulating Immuno-complex (v) TSH Receptor antibodies (vi) Anti-Cardiolipin antibodies
27		Rheumatoid- Inflammatory Diseases Markers	(i) Anti-Streptococcal Hyaluronidase (ii) Anti-Streptokinase (iii) Anti-Streptolysin O (iv) C-Reactive Protein (v) Anti-Staphylolysin (vi) Anti-Streptococcal Screening
28		Liver Function	(i) MEGX (ii) Carbohydrate Deficient Transferrin
29		Cardiac Markers	(i) BNP/proBNP

			(ii) Creatine Kinase - MB (iii) Myoglobin (iv) Troponin I/T (v) Homocysteine (vi) High-Sensitivity C-Reactive Protein
30		Bacterial Infection - Immunology	(i) <i>Bacillus subtilis</i> (ii) <i>Escherichia coli</i>
31		Viral Infection - Immunology	(i) Influenza virus
32		Parasitic Infection - Immunology	(i) <i>Entamoebahistolytica</i> (ii) <i>Leishmania</i>
33		Fungal Infection - Immunology	(i) <i>Candida albicans</i> (ii) <i>Aspergillus</i>
34	Haematology (Blood tests for transfusions excluded)	Hemoglobin Testing	(i) Hemoglobin determinations (Total Hb) (ii) Fractional oxyhemoglobin (FO2Hb) (iii) Fractional carboxyhemoglobin (FCOHb) (iv) Fractional methemoglobin (FMetHb) (v) Fractional deoxyhemoglobin (FHHb)
35		General Coagulation Tests	(i) Prothrombin Time (ii) Thrombin Time (iii) Activated Clotting Time (iv) Activated Partial Thromboplastin Time
36		Haemostasis (Coagulation)	(i) Prothrombin (ii) Thrombin (iii) Fibrinogen (iv) Protein C and Protein S reagents

			<ul style="list-style-type: none"> <li>(v) C1-inhibitors</li> <li>(vi) Heparin</li> <li>(vii) Alpha-Antiplasmin</li> <li>(viii) Fibrin</li> <li>(ix) Factor XIII</li> <li>(x) Platelet Factor 4</li> <li>(xi) Plasminogen</li> </ul>
37	Histology/Cytology	Other Hematology Tests	<ul style="list-style-type: none"> <li>(i) Complete Blood count</li> <li>(ii) Hematocrit</li> <li>(iii) Erythrocyte Sedimentation rate</li> </ul>
38		Cytokines (Lymphokines)/ Immunomodulators	<ul style="list-style-type: none"> <li>(i) Interferons</li> <li>(ii) Soluble Antigens/Receptors</li> <li>(iii) Tumor Necrosis Factors</li> <li>(iv) Interleukins</li> <li>(v) Colony Stimulating Factors</li> <li>(vi) Tumor Necrosis Factors Receptors</li> <li>(vii) Interleukins Receptors</li> </ul>
39		Histology/ Cytology Reagents	<ul style="list-style-type: none"> <li>(i) Cytochemical Staining</li> <li>(ii) Embedding, Fixing, Mounting media</li> <li>(iii) Stain solutions</li> <li>(iv) Immunohistology kits</li> </ul>
40	Microbiology - culture (i) Cytochemical Staining (ii) Embedding, Fixing, Mounting media (iii) Stain solutions (iv) Immunohistology kits	Culture Media	<ul style="list-style-type: none"> <li>(i) Dehydrated culture media (DCM)</li> <li>(ii) Additives for DCM</li> <li>(iii) Prepared Media (Tubes, bottles, Plates)</li> <li>(iv) Cells, Media, Serum for Viral culture</li> </ul>
41		Susceptibility Testing	(i) Erythromycin susceptibility test for <i>Staphylococcus aureus</i>



		Identification of bacteria by testing for the susceptibility of the bacteria to the certain antibiotics.	(ii) Tobramycin susceptibility test for <i>Pseudomonas aeruginosa</i>  (iii) Fungal susceptibility testing
42		Biochemical culture Identification (ID)	(i) Gram Negative Manual ID  (ii) Gram Positive Manual ID  (iii) Other ID Kits Manual - Anaerobes, Fastidious  (iv) Mycoplasma
43		Immunological culture Identification (ID)	(i) Streptococci Grouping Slide tests  (ii) Serotyping (E.coli, Salmonella, Shigella etc.)
44		Nucleic Acid (NA) based culture identification (ID)	(i) NA Identification – MRSA  (ii) NA Identification – Other resistance markers
45		Serological identification (ID)	(i) For Parasitology and Mycology (Fungi and Yeast)
46	Molecular Biology	Oncogenes  Genes, whose mutation or enhanced expression, turns a normal cell into a cancer cell.	(i) p53  (ii) MYC (8q24)  (iii) TERC (3q26)
47		Bacterial Infections (Detection by NA Reagents)	(i) Staphylococcal detection  (ii) E.coli detection
48		Viral Infections (Detection by NA Reagents)	(i) Influenza and Para-influenza NA Reagents
49		Fungal Infections	(i) Fungi NA Reagents

**ANNEX 7:** Decision Flowchart for Grouping of Products as An IVD Cluster

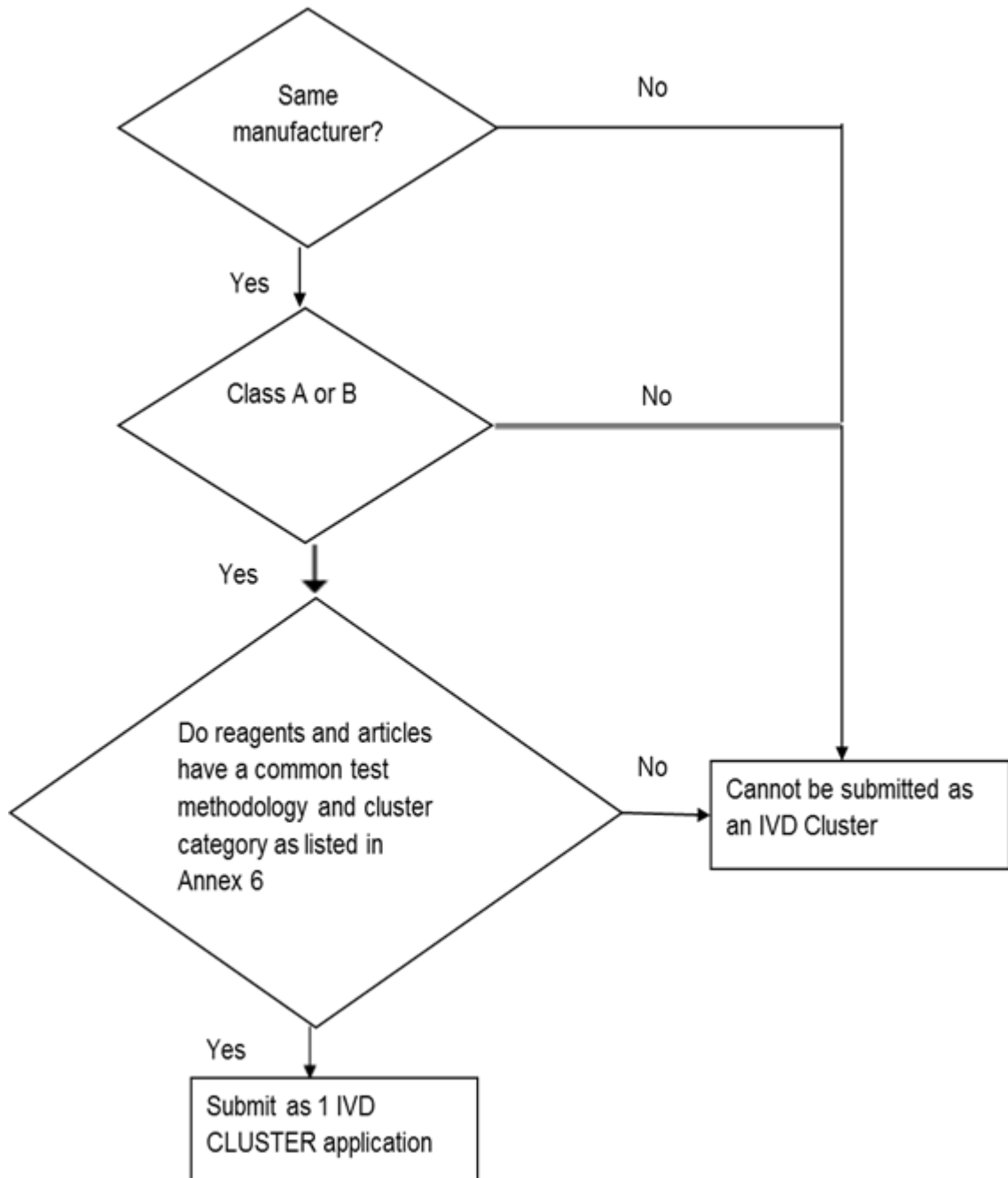

# MEDICAL DEVICE AUTHORITY

---

## MINISTRY OF HEALTH, MALAYSIA

### Contact Information:

Registration, Licensing and Enforcement Division  
IVD Registration Unit  
Medical Device Authority  
Ministry of Health  
Malaysia

Level 6, Prima 9, Prima Avenue II,  
Block 3547, Persiaran APEC,  
63000 Cyberjaya, Selangor,  
MALAYSIA

**T:** (03) 8230 0300

**F:** (03) 8230 0200

**Website:** <http://www.mdb.gov.my>

